

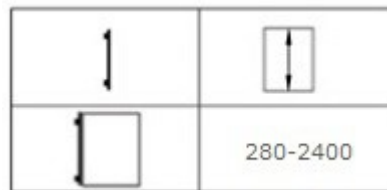

Getribe – Okretno-nagibni sistem

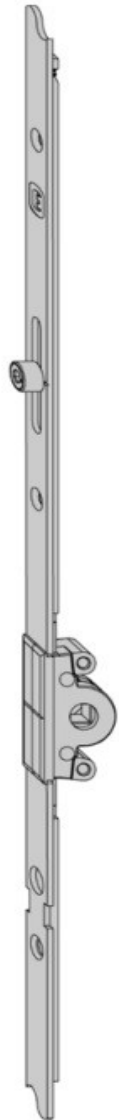



| KOD | Gr oznaka | Za falcne dimenzije (mm) |  |  |
|------------|-----------|--------------------------|---|---|
| 1-11115-04 | Gr00 | 280-620 | - | 0 |
| 1-11115-05 | Gr01 | 620-900 | 2 | 0 |
| 1-11115-07 | Gr02 | 750-1150 | 3 | 1 |
| 1-11115-09 | Gr02.1 | 900-1300 | 4 | 1 |
| 1-11115-10 | Gr03 | 1000-1400 | 6 | 1 |
| 1-11115-12 | Gr03.1 | 1201-1600 | 7 | 1 |
| 1-11115-16 | Gr04 | 1601-2000 | 9 | 2 |
| 1-11115-18 | Gr05 | 1801-2200 | 12 | 2 |
| 1-11115-20 | Gr06 | 2001-2400 | 12 | 2 |

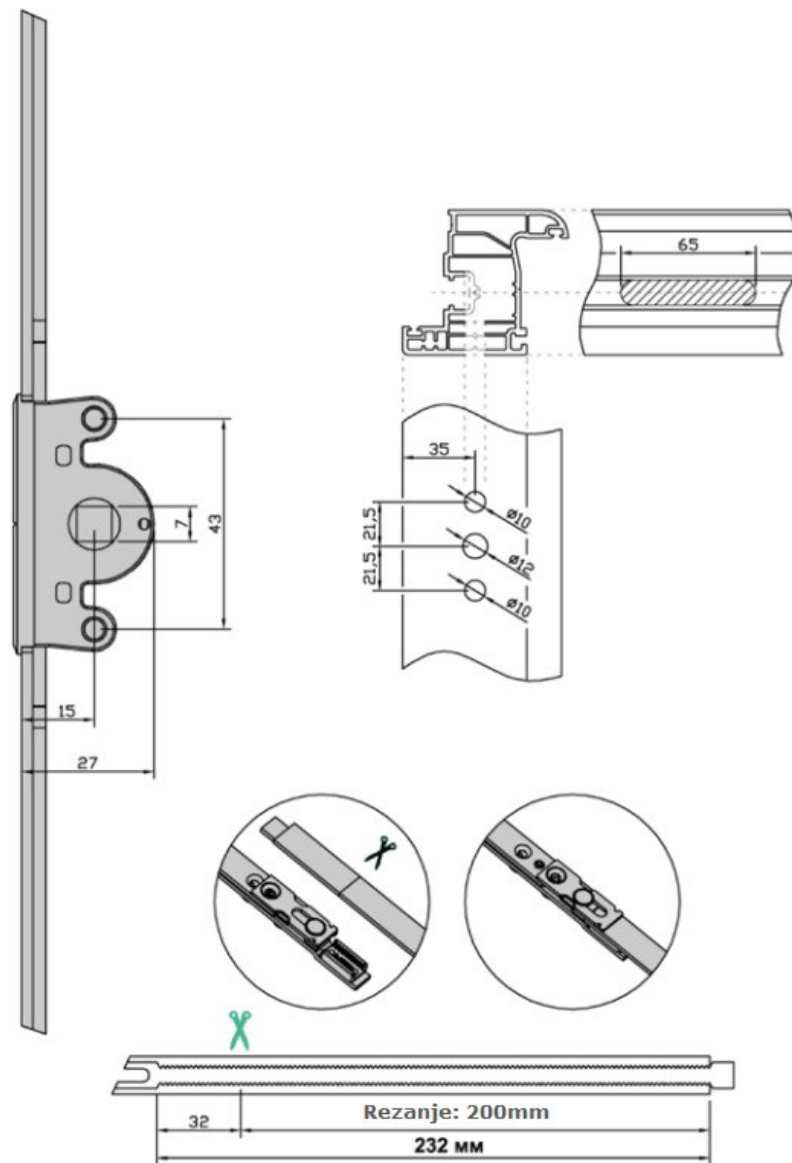

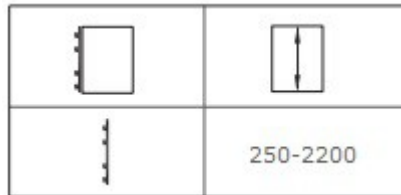
Getribe – Obično otvaranje



| KOD | Gr oznaka | Za falcne dimenzije (mm) |  |  |
|------------|-----------|--------------------------|---|---|
| 1-61053-02 | Gr02 | 250-450 | 2 | 2 |
| 1-61053-04 | Gr04 | 400-600 | 4 | 2 |
| 1-61053-06 | Gr06 | 601-800 | 6 | 2 |
| 1-61053-08 | Gr08 | 801-900 | 8 | 3 |
| 1-61053-09 | Gr09 | 901-1000 | 8 | 3 |
| 1-61053-10 | Gr10 | 1001-1100 | 10 | 3 |
| 1-61053-11 | Gr11 | 1101-1200 | 10 | 3 |
| 1-61053-12 | Gr12 | 1201-1300 | 10 | 3 |
| 1-61053-13 | Gr13 | 1301-1400 | 10 | 3 |
| 1-61053-14 | Gr14 | 1401-1500 | 12 | 3 |
| 1-61053-15 | Gr15 | 1501-1600 | 12 | 3 |
| 1-61053-16 | Gr16 | 1601-1800 | 13 | 4 |
| 1-61053-18 | Gr18 | 1801-2000 | 14 | 4 |
| 1-61053-20 | Gr20 | 2001-2200 | 15 | 4 |

