





Petozatvorna brava bez jezička

The technical drawing shows a vertical pet lock assembly with various components labeled 1 through 6. Detail views show the handle assembly (labeled 2) and the lock body assembly (labeled 3). A pair of scissors icon indicates where to cut the assembly line.

RB	KOD	NAZIV	DUŽINA (mm)	ZA DIMENZIJE OD-DO (mm)		
1	71020.16	35-85 POGONSKA BRAVA VRATA BJ	1600	1600-1800	10	4
	71020.18	35-85 POGONSKA BRAVA VRATA BJ	1800	1800-2000	10	4
	71020.20	35-85 POGONSKA BRAVA VRATA BJ	2000	2000-2200	12	4
	71024.16	28-85 POGONSKA BRAVA VRATA BJ	1600	1600-1800	10	4
	71024.18	28-85 POGONSKA BRAVA VRATA BJ	1800	1800-2000	10	4
	71024.20	28-85 POGONSKA BRAVA VRATA BJ	2000	2000-2200	12	4
	71037.16	25-85 POGONSKA BRAVA VRATA BJ	1600	1600-1800	10	4
	71037.18	25-85 POGONSKA BRAVA VRATA BJ	1800	1800-2000	10	4
	71037.20	25-85 POGONSKA BRAVA VRATA BJ	2000	2000-2200	12	4
	71028.16	35-92 POGONSKA BRAVA VRATA BJ	1600	1600-1800	10	4
	71028.18	35-92 POGONSKA BRAVA VRATA BJ	1800	1800-2000	10	4
	2	11371.16	UGAONIK STANDARD			4
3	11375.16	UGAONIK SECURITY			4	1
4	32807.13	PRIHVATNIK STANDARD			4	
5	21003.00	PRIHVATNIK ZA PETOZATVORNU BRAVU BEZ JEZIČKA			4	
5	21006.00	PRIHVATNIK ZA PETOZATVORNU BRAVU BEZ JEZIČKA			4	
6	21005.00	PRIHVATNIK ZA PETOZATVORNU BRAVU			4	

Petozatvorna brava sa jezičkom

RB	KOD	NAZIV	DUŽINA (mm)	ZA DIMENZIJE OD-DO (mm)		
1	71019.16	35-85 POGONSKA BRAVA VRATA SJ	1600	1600-1800	10	4
	71019.18	35-85 POGONSKA BRAVA VRATA SJ	1800	1800-2000	10	4
	71019.20	35-85 POGONSKA BRAVA VRATA SJ	2000	2000-2200	12	4
	71023.16	28-85 POGONSKA BRAVA VRATA SJ	1600	1600-1800	10	4
	71023.18	28-85 POGONSKA BRAVA VRATA SJ	1800	1800-2000	10	4
	71023.20	28-85 POGONSKA BRAVA VRATA SJ	2000	2000-2200	12	4
	71027.16	35-92 POGONSKA BRAVA VRATA SJ	1600	1600-1800	10	4
	71027.18	35-92 POGONSKA BRAVA VRATA SJ	1800	1800-2000	10	4
	71038.16	25-85 POGONSKA BRAVA VRATA SJ	1600	2000-2200	12	4
	71038.18	25-85 POGONSKA BRAVA VRATA SJ	1800	1600-1800	10	4
2	11371.16	UGAONIK STANDARD			4	1
3	11375.16	UGAONIK SECURITY			4	1
4	32807.13	PRIHVATNIK STANDARD			4	
5	21005.00	PRIHVATNIK ZA PETOZATVORNU BRAVU			4	

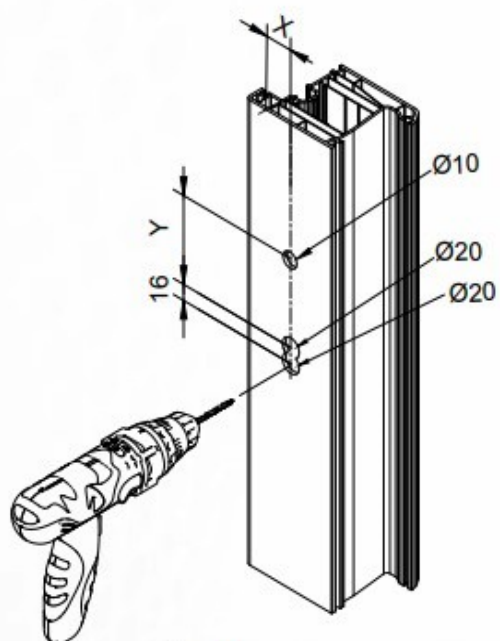

Priprema otvora na profilu			
X	Y	K	Z
35	85	230	55
35	92	240	55
28	85	230	48
28	92	240	48
25	85	230	45

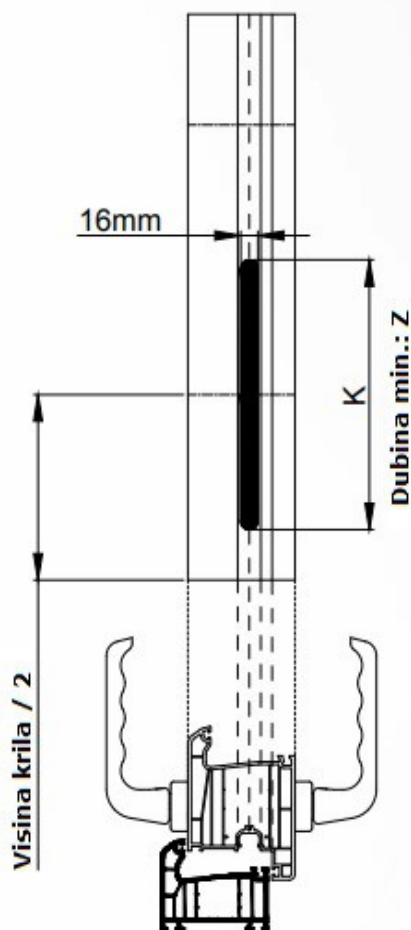

35x85mm



28x85 / 28x92 / 25x85mm

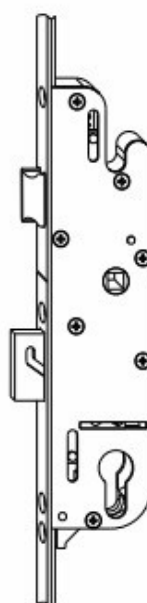

35x92mm